

PLAN DE DRISSAGE / TIRAGE 01
PATIENCE EN 2 PARTIES À CHEVAUCHEMENT CENTRAL
(VUE DE DESSOUS)

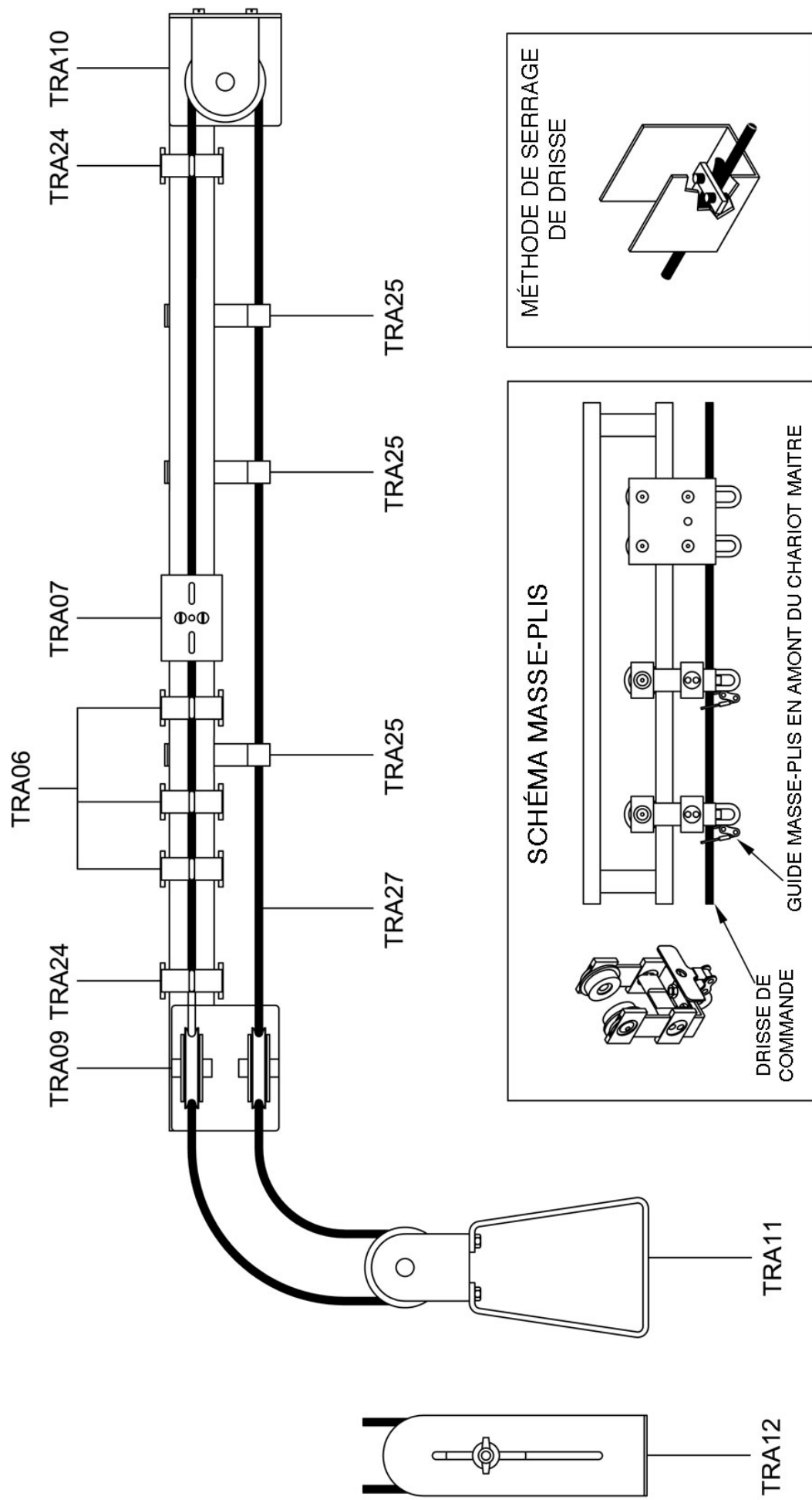

PLAN DE DRESSAGE / TIRAGE 02
PATIENCE SIMPLE A OUVERTURE LATÉRALE
(VUE DE DESSOUS)

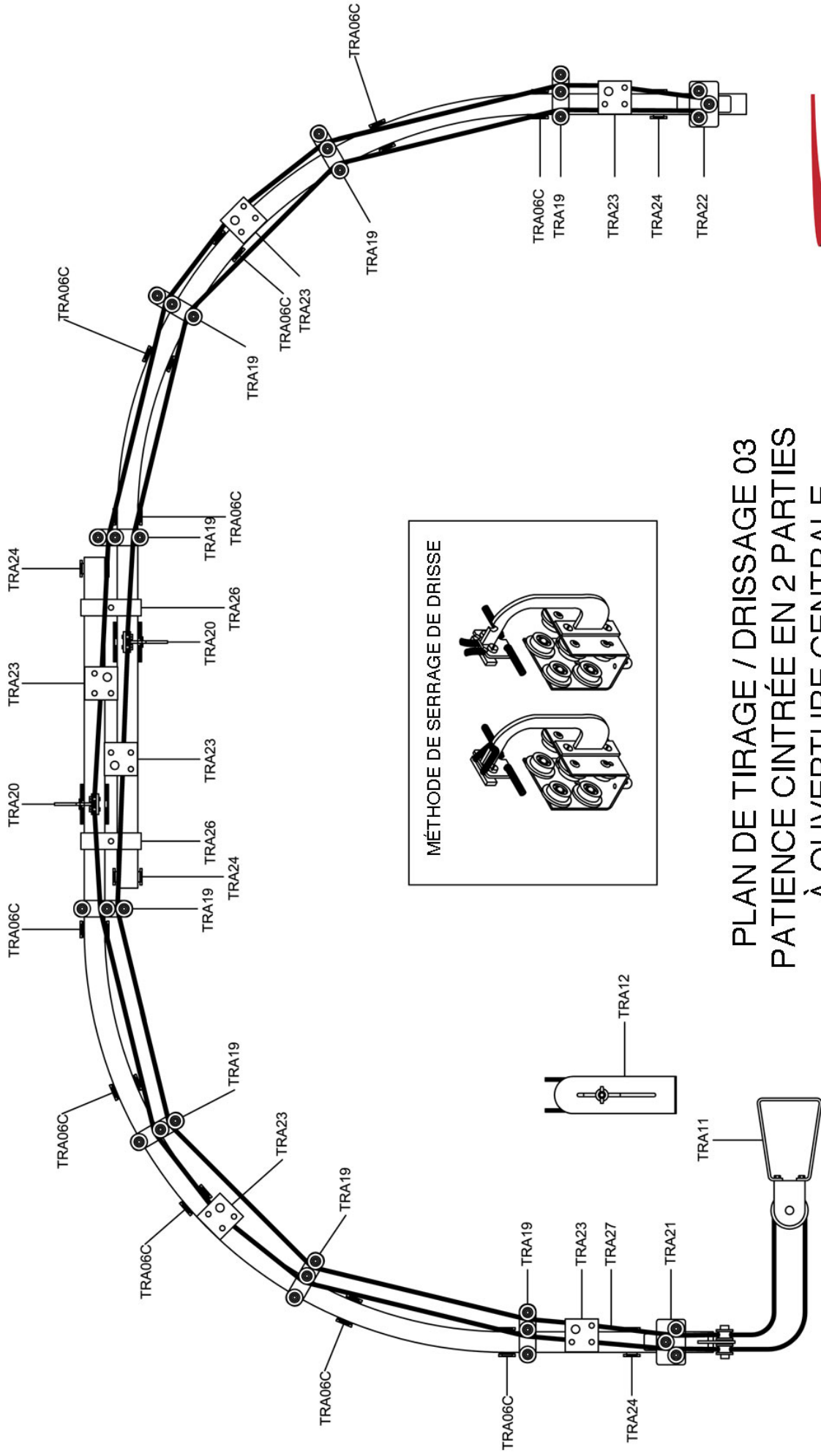

PLAN DE TIRAGE / DRISSAGE 03
 PATIENCE CINTRÉE EN 2 PARTIES
 À OUVERTURE CENTRALE
 (VUE DE DESSUS)



Tél : 01 40 11 50 50
 www.blackout.fr
 info@blackout.fr

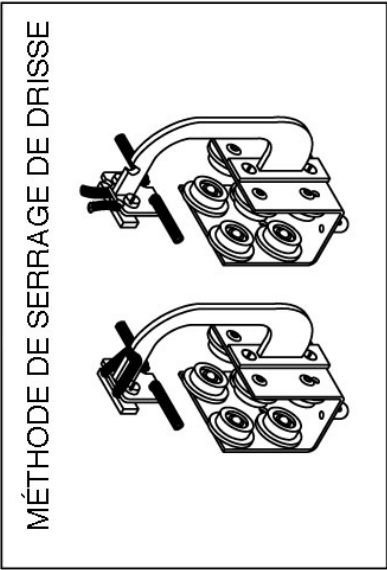
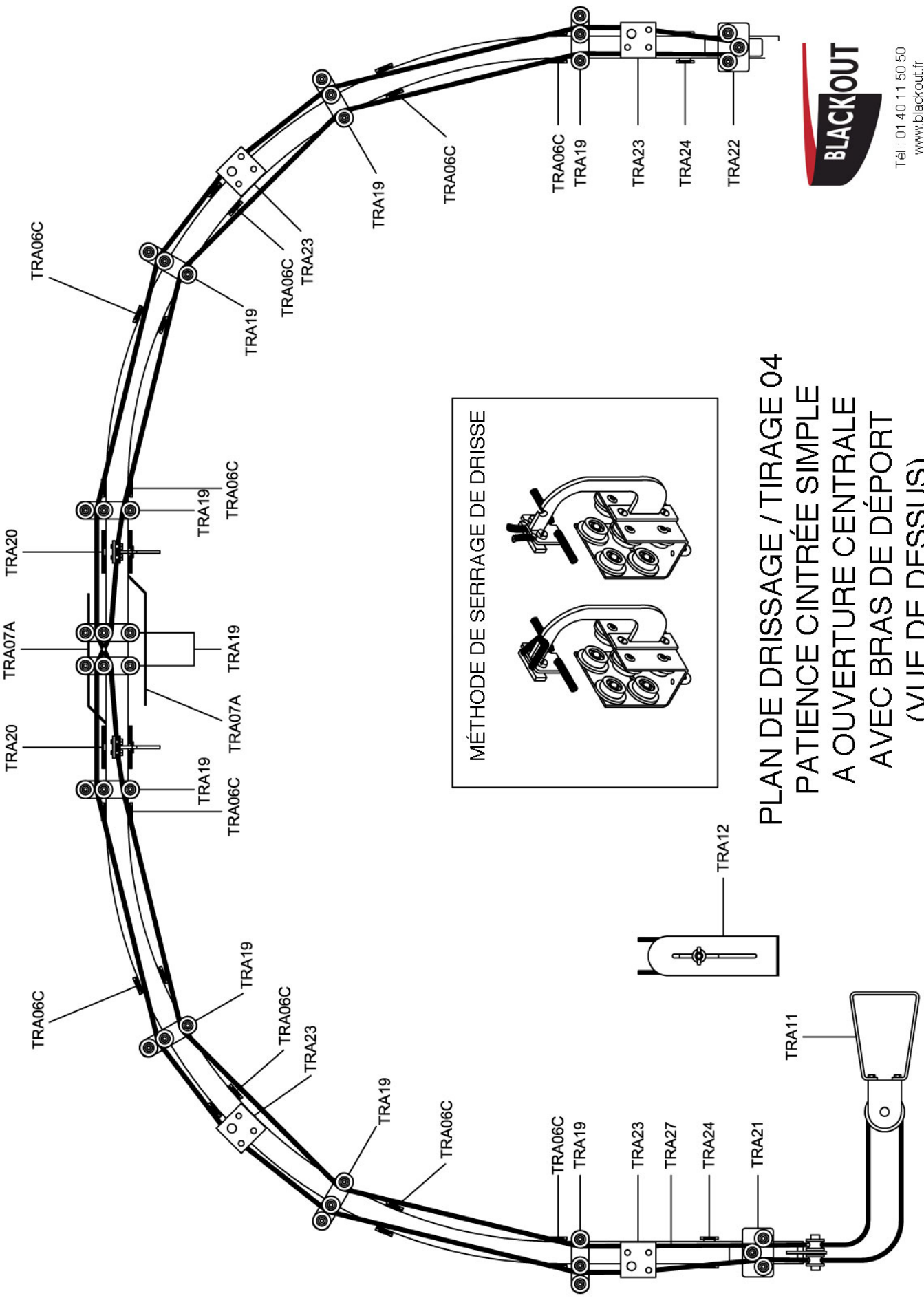

MÉTHODE DE SERRAGE DE DRISSE

PLAN DE DRISSAGE / TIRAGE 04
PATIENCE CINTRÉE SIMPLE
A OUVERTURE CENTRALE
AVEC BRAS DE DÉPORT
(VUE DE DESSUS)



Tél : 01 40 11 50 50
 www.blackout.fr
 info@blackout.fr

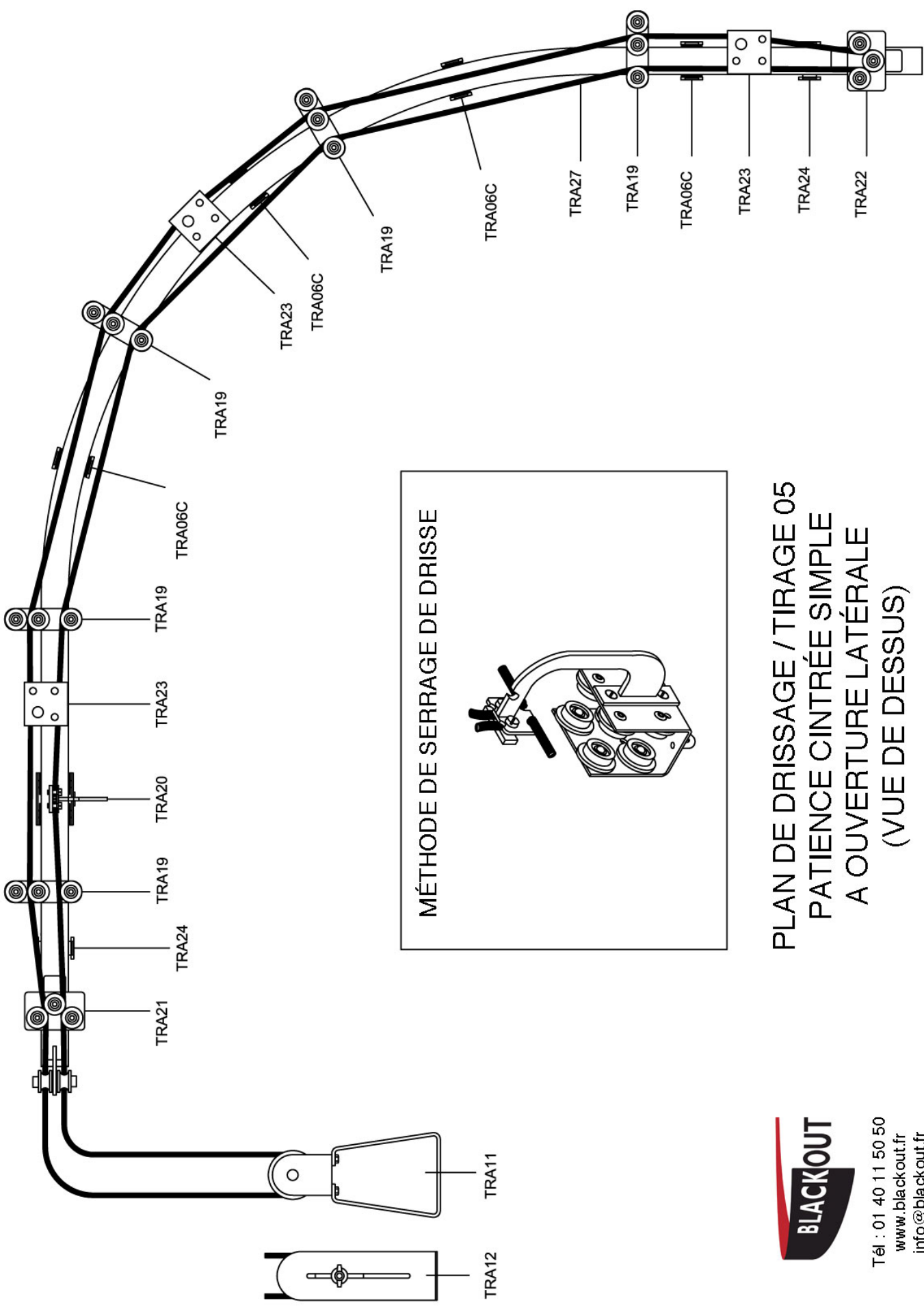

MÉTHODE DE SERRAGE DE DRISSE

PLAN DE DRISSAGE / TIRAGE 05
 PATIENCE CINTRÉE SIMPLE
 A OUVERTURE LATÉRALE
 (VUE DE DESSUS)



Tél : 01 40 11 50 50
 www.blackout.fr
 info@blackout.fr

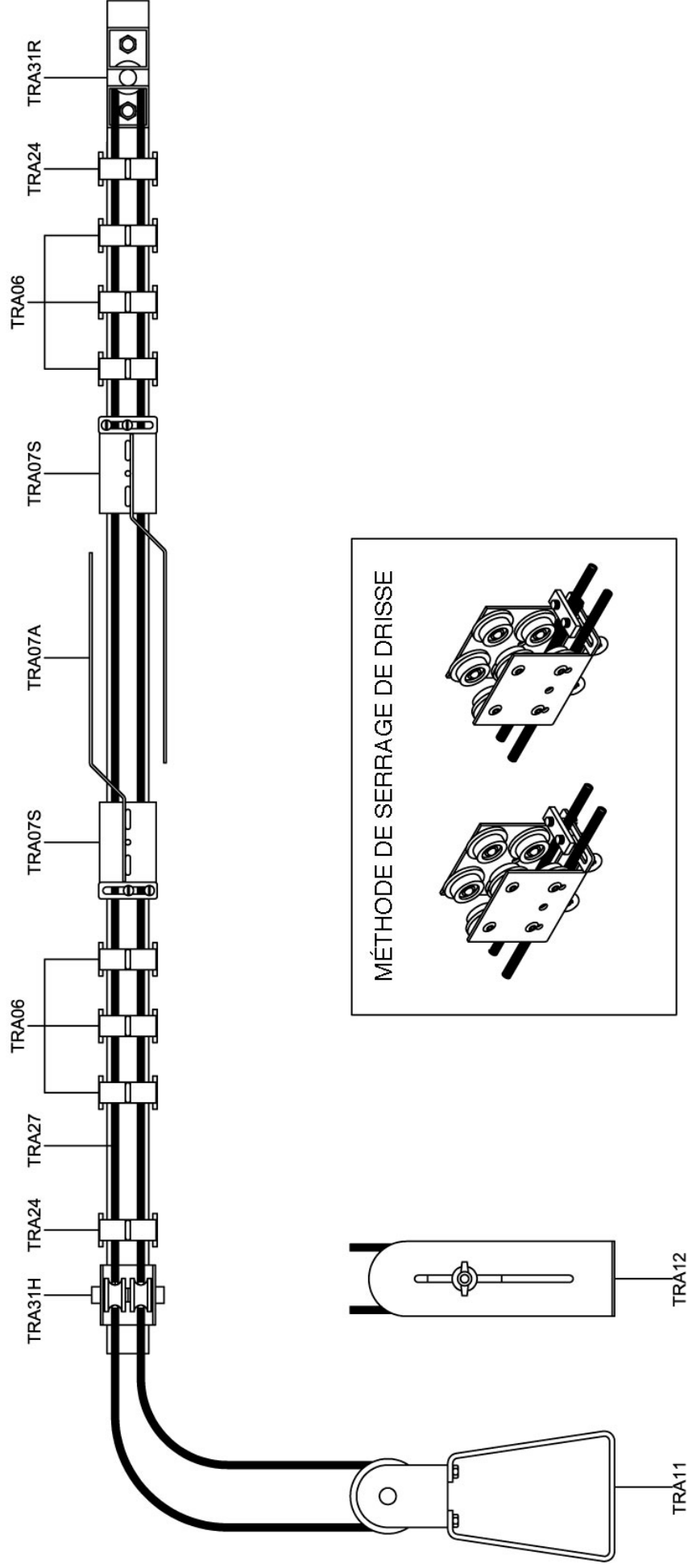

MÉTHODE DE SERRAGE DE DRISSE

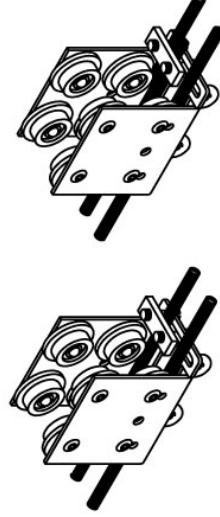

PLAN DE DRISSAGE / TIRAGE 06
 PATIENCE SIMPLE
 A OUVERTURE CENTRALE
 AVEC BRAS DE DÉPORT
 (VUE DE DESSOUS)



Tél : 01 40 11 50 50
 www.blackout.fr
 info@blackout.fr

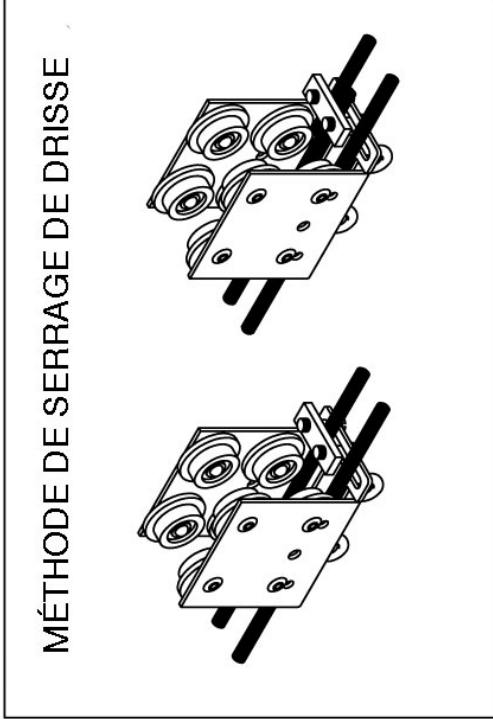
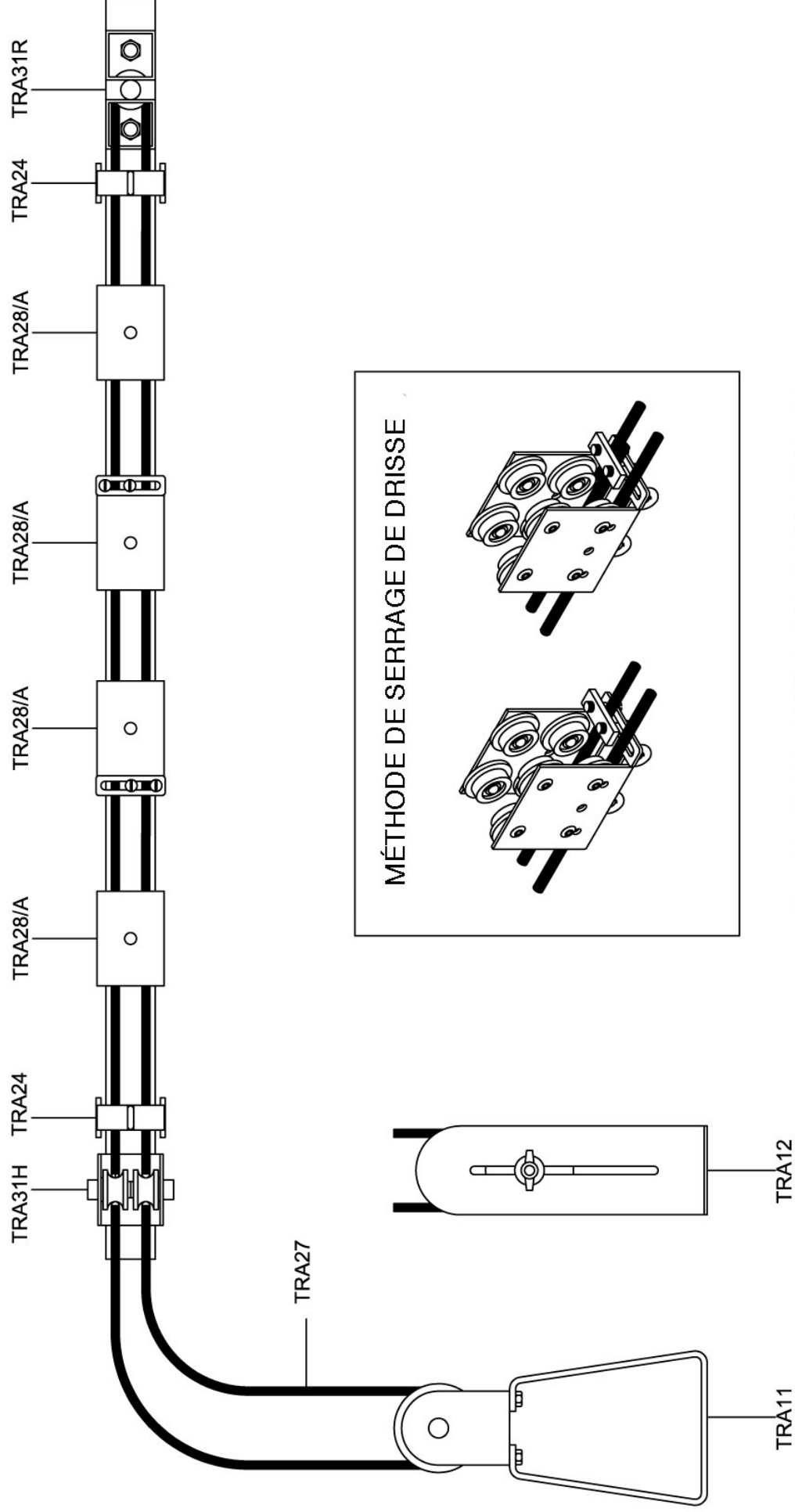

PLAN DE DRISSAGE / TIRAGE 07
PATIENCE POUR DÉCORS SIMPLES
A BUTÉE CENTRALE
(VUE DE DESSOUS)



Tél : 01 40 11 50 50
 info@blackout.fr
 www.blackout.fr

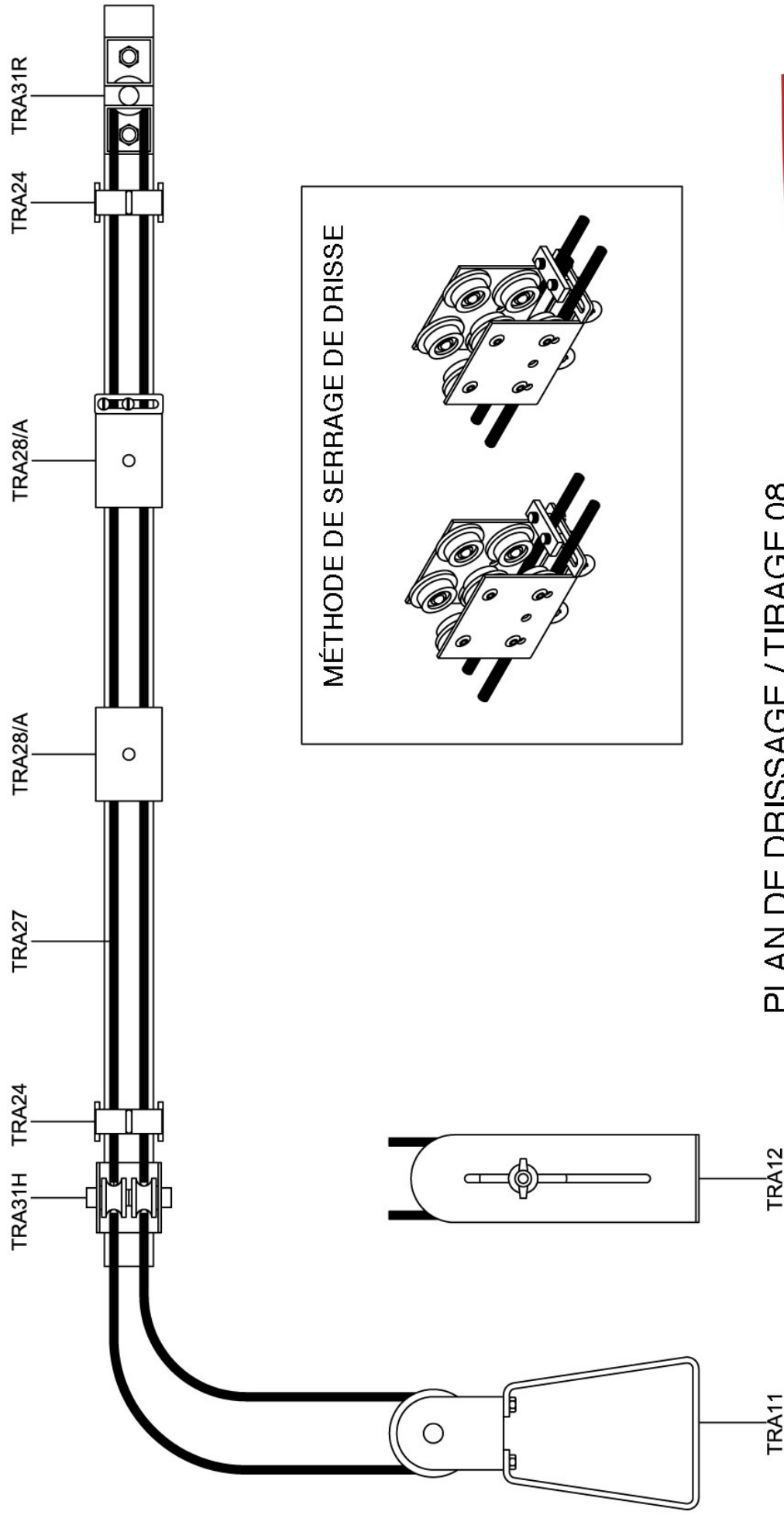

MÉTHODE DE SERRAGE DE DRISSE

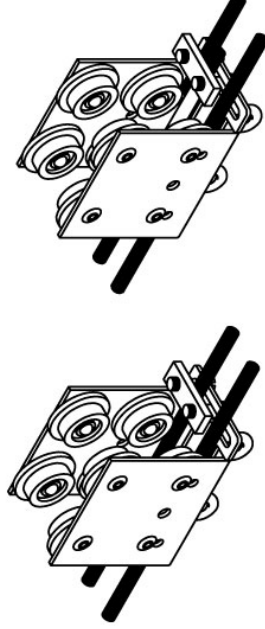

PLAN DE DRISSAGE / TIRAGE 08
 PATIENCE POUR DÉCORS SIMPLES
 POUR TRANSLATION LATÉRALE
 (VUE DE DESSOUS)



Tél : 01 40 11 50 50
 info@blackout.fr
 www.blackout.fr

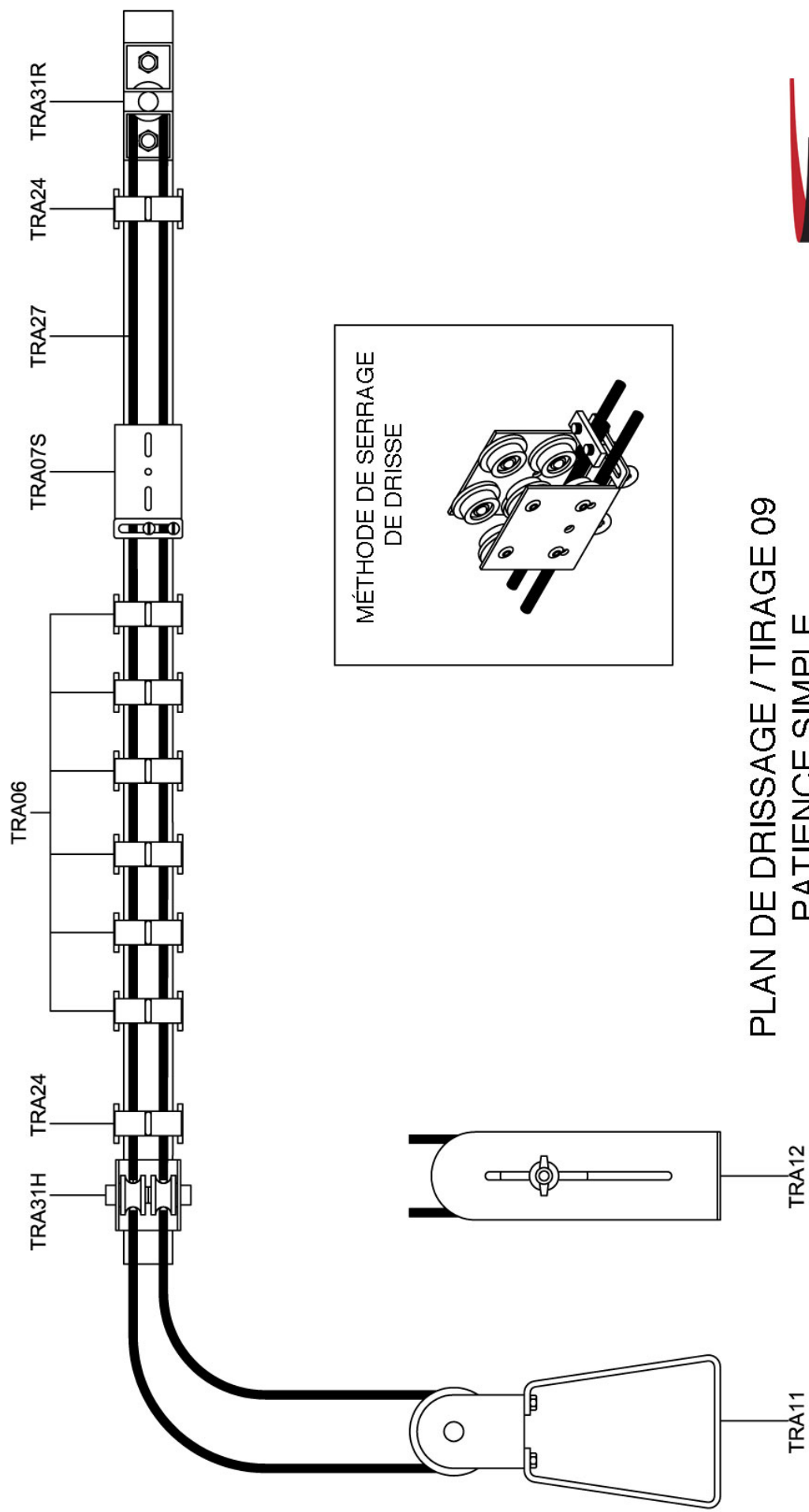

PLAN DE DRISSAGE / TIRAGE 09
PATIENCE SIMPLE
A OUVERTURE LATÉRALE
POUR RIDEAUX
(VUE DE DESSOUS)



Tél : 01 40 11 50 50
 info@blackout.fr
 www.blackout.fr

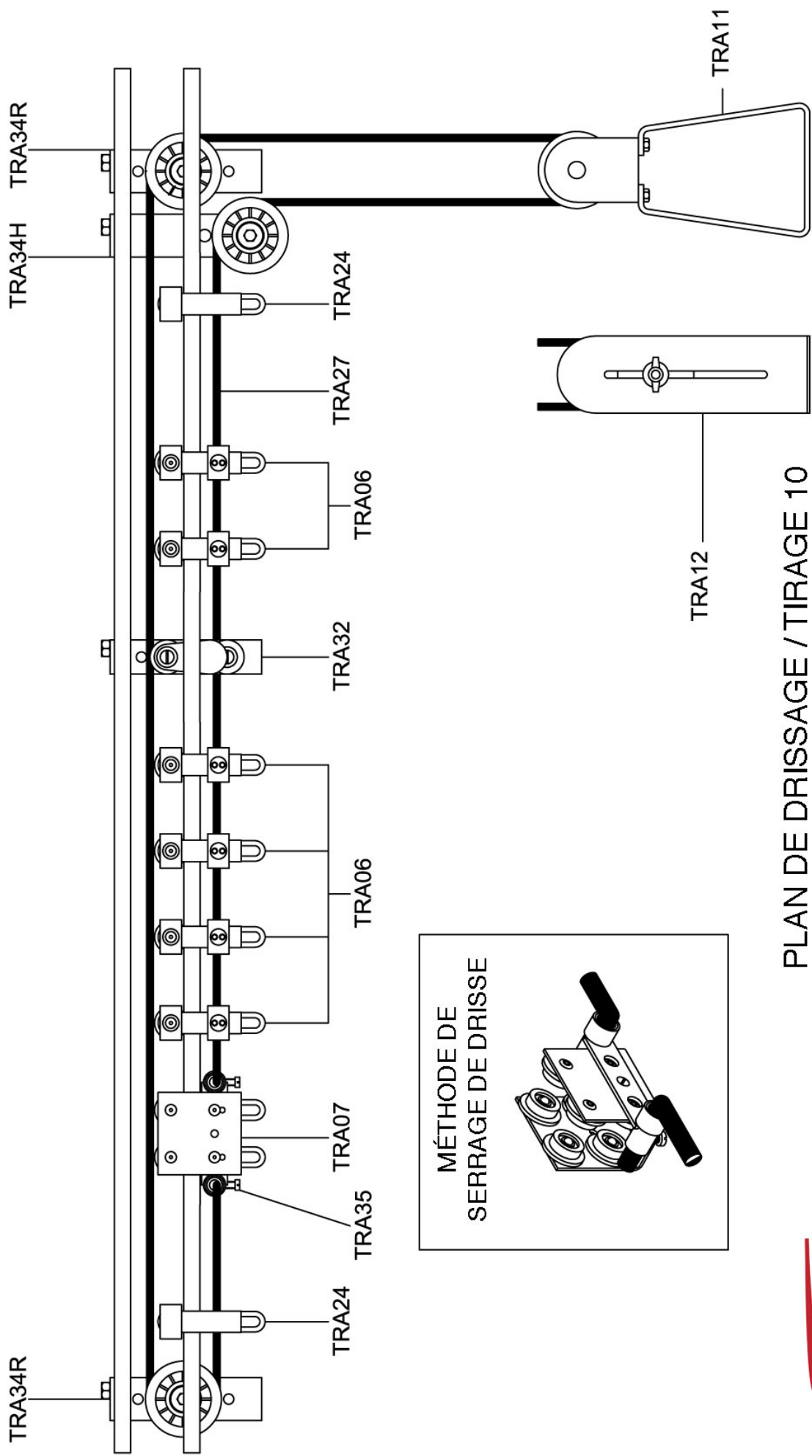

PLAN DE DRISSAGE / TIRAGE 10
 DRISSAGE LATÉRAL DE
 PATIENCE SIMPLE
 A OUVERTURE LATÉRALE
 (VUE DE CÔTÉ)



Tél : 01 40 11 50 50
 info@blackout.fr
 www.blackout.fr

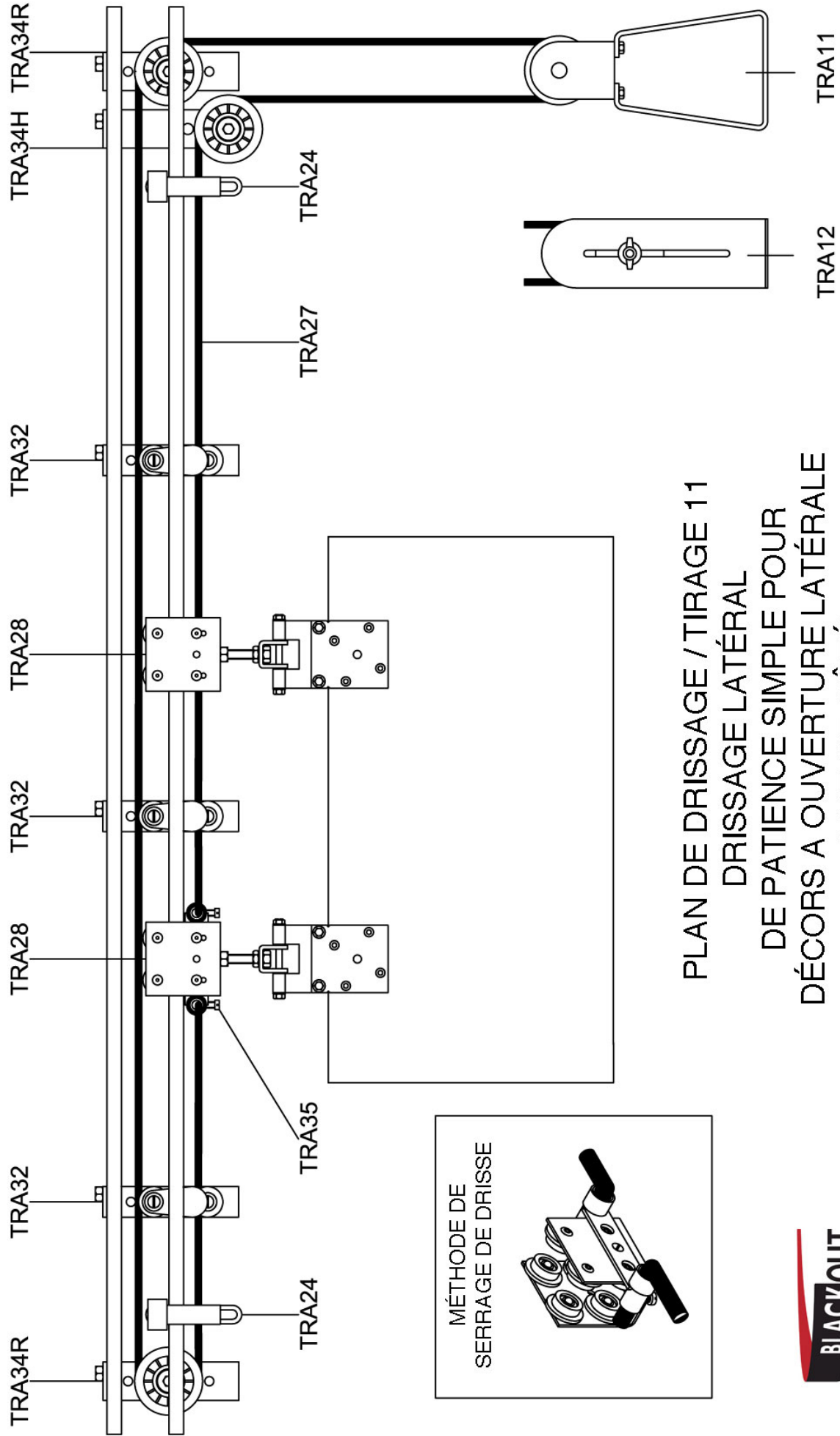

PLAN DE DRESSAGE / TIRAGE 11
 DRESSAGE LATÉRAL
 DE PATIENCE SIMPLE POUR
 DÉCORS A OUVERTURE LATÉRALE
 (VUE DE CÔTÉ)



Tél : 01 40 11 50 50
 info@blackout.fr
 www.blackout.fr

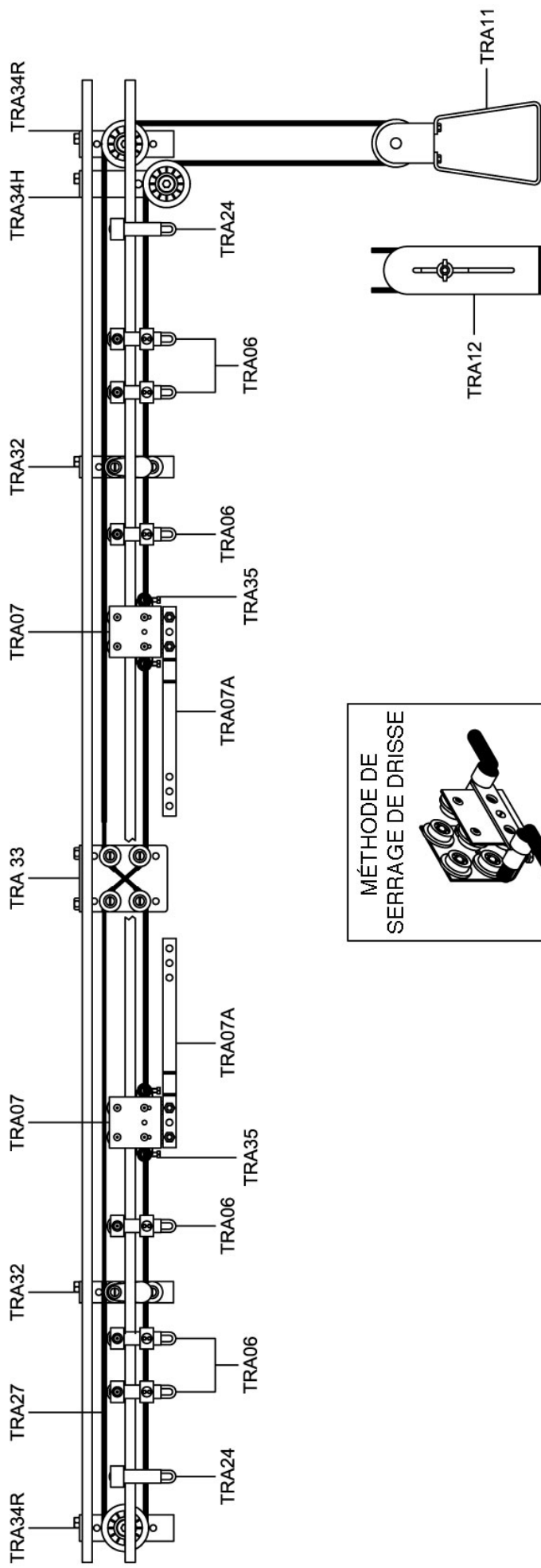

Tél : 01 40 11 50 50
 info@blackout.fr
 www.blackout.fr

PLAN DE DRISSAGE / TIRAGE 12
DRISSAGE A OUVERTURE CENTRALE
AVEC BRAS DE DÉPORT
(VUE DE CÔTÉ)

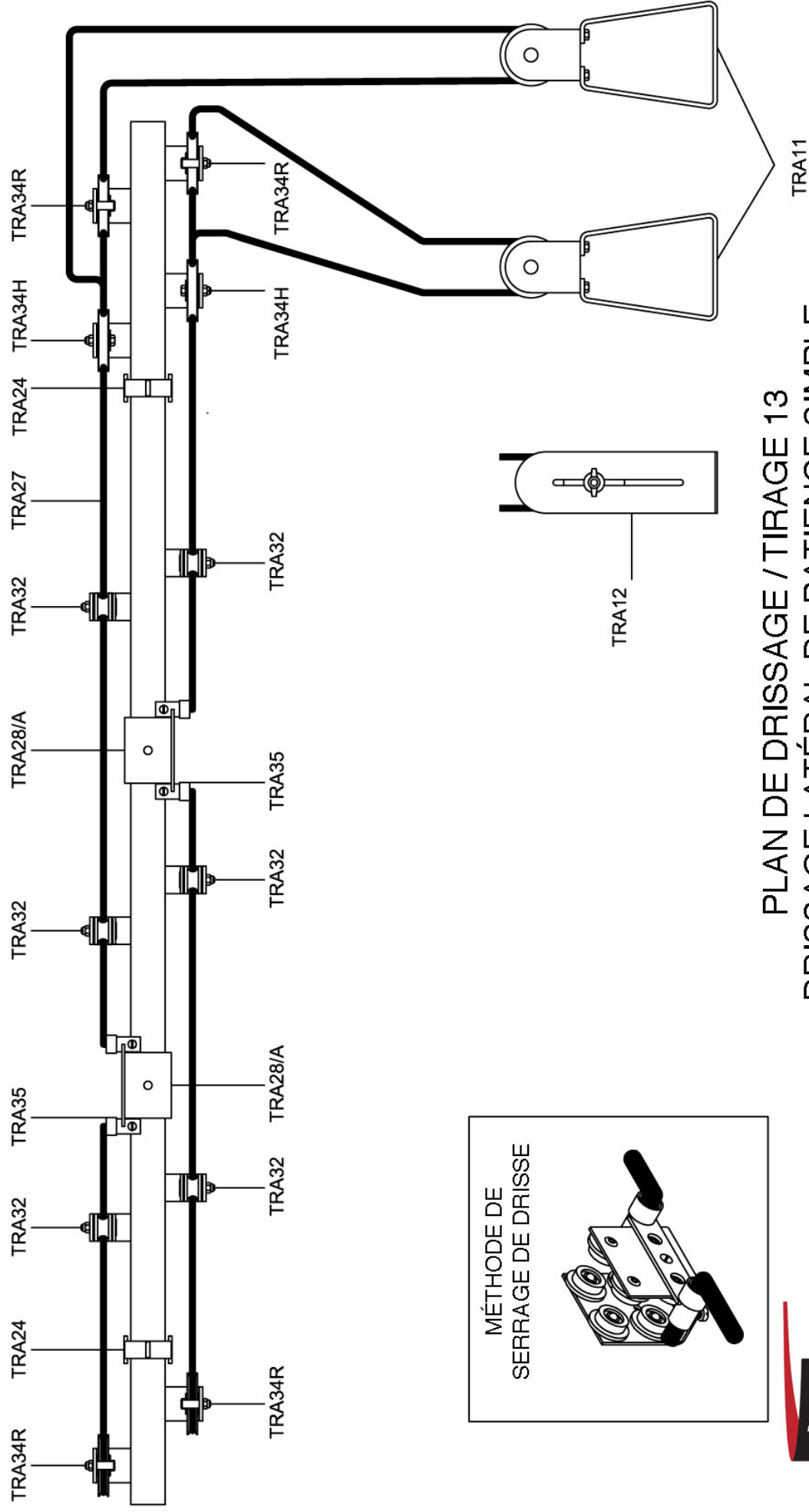

PLAN DE DRISSAGE / TIRAGE 13
 DRISSAGE LATÉRAL DE PATIENCE SIMPLE
 POUR DÉCORS À CHARIOTS INDÉPENDANTS
 (VUE DE DESSOUS)

MÉTHODE DE
 SERRAGE DE DRISSE

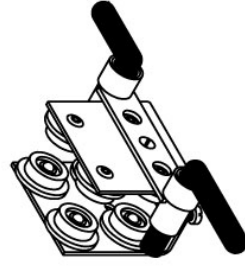

Tél : 01 40 11 50 50
 info@blackout.fr
 www.blackout.fr

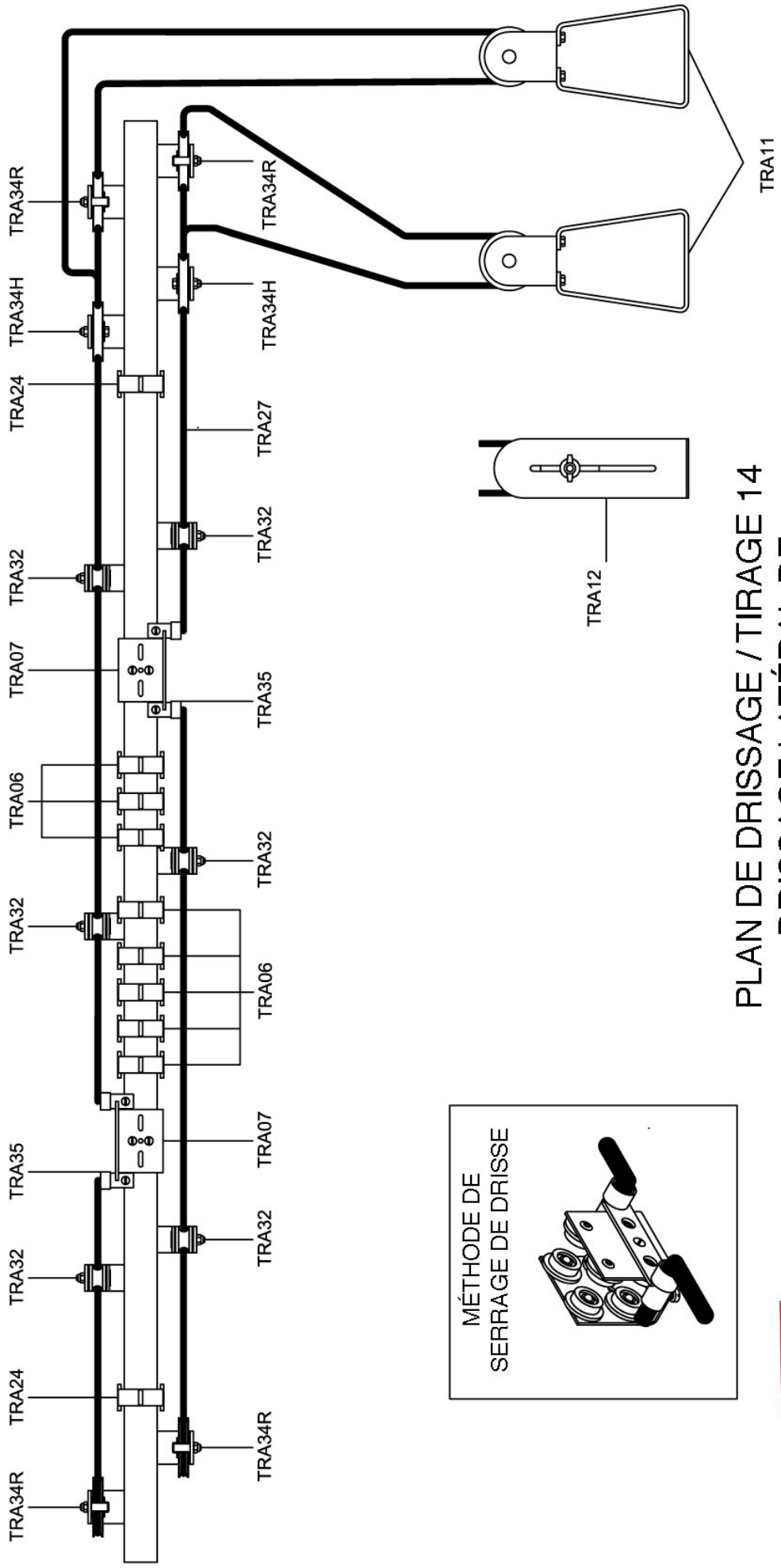

PLAN DE DRISSAGE / TIRAGE 14
 DRISSAGE LATÉRAL DE
 PATIENCE SIMPLE AVEC
 CHARIOTS MAITRE INDÉPENDANTS
 (VUE DE DESSOUS)



BLACKOUT
 Tél : 01 40 11 50 50
 info@blackout.fr
 www.blackout.fr

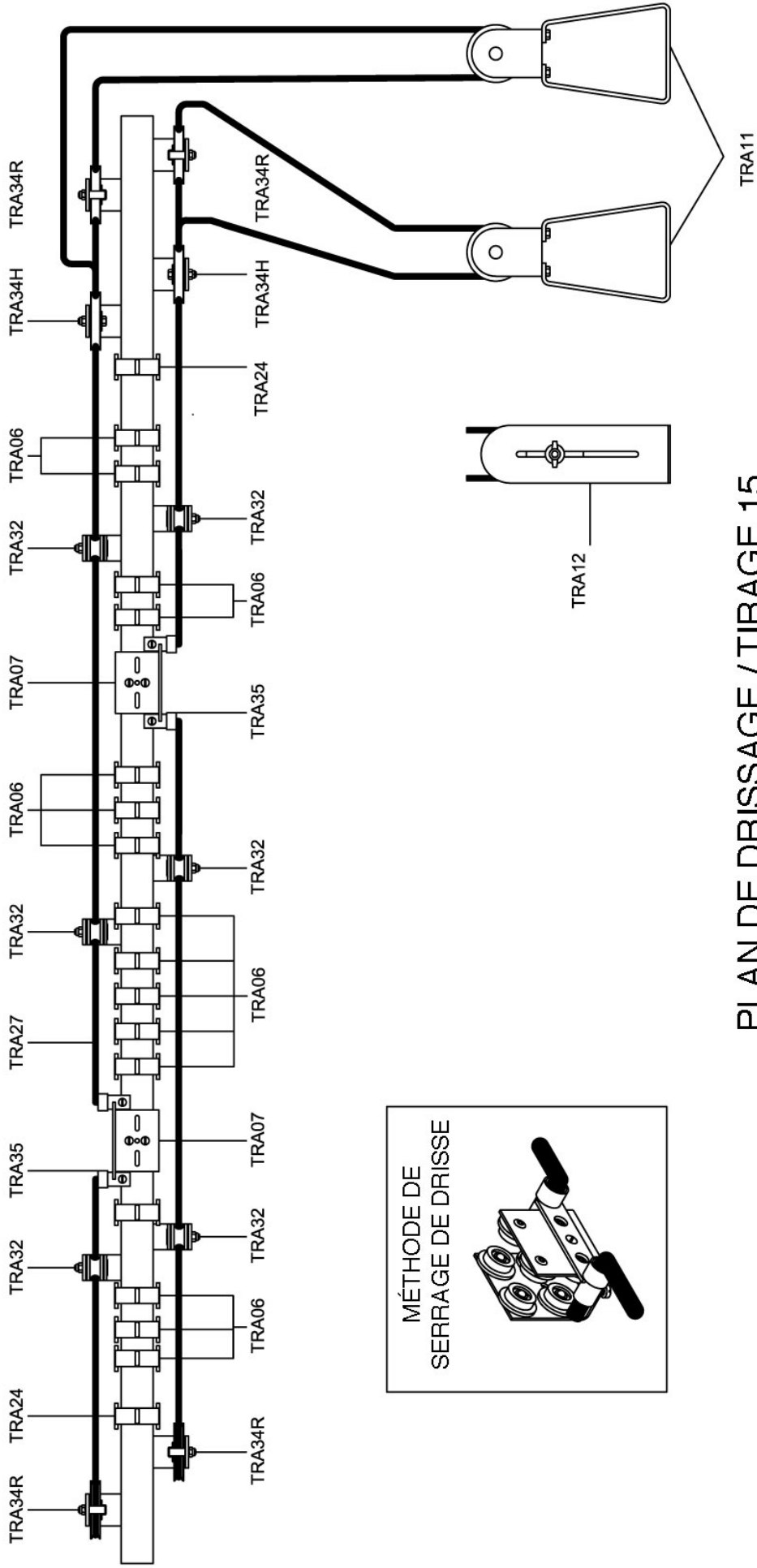

PLAN DE DRISSAGE / TIRAGE 15
DRISSAGE LATÉRAL DE PATIENCE SIMPLE
AVEC CHARIOTS MAÎTRE INDÉPENDANTS
(VUE DE DESSOUS)



Tél : 01 40 11 50 50
info@blackout.fr
www.blackout.fr

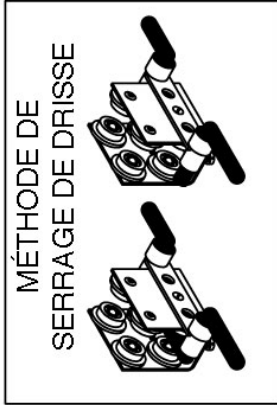
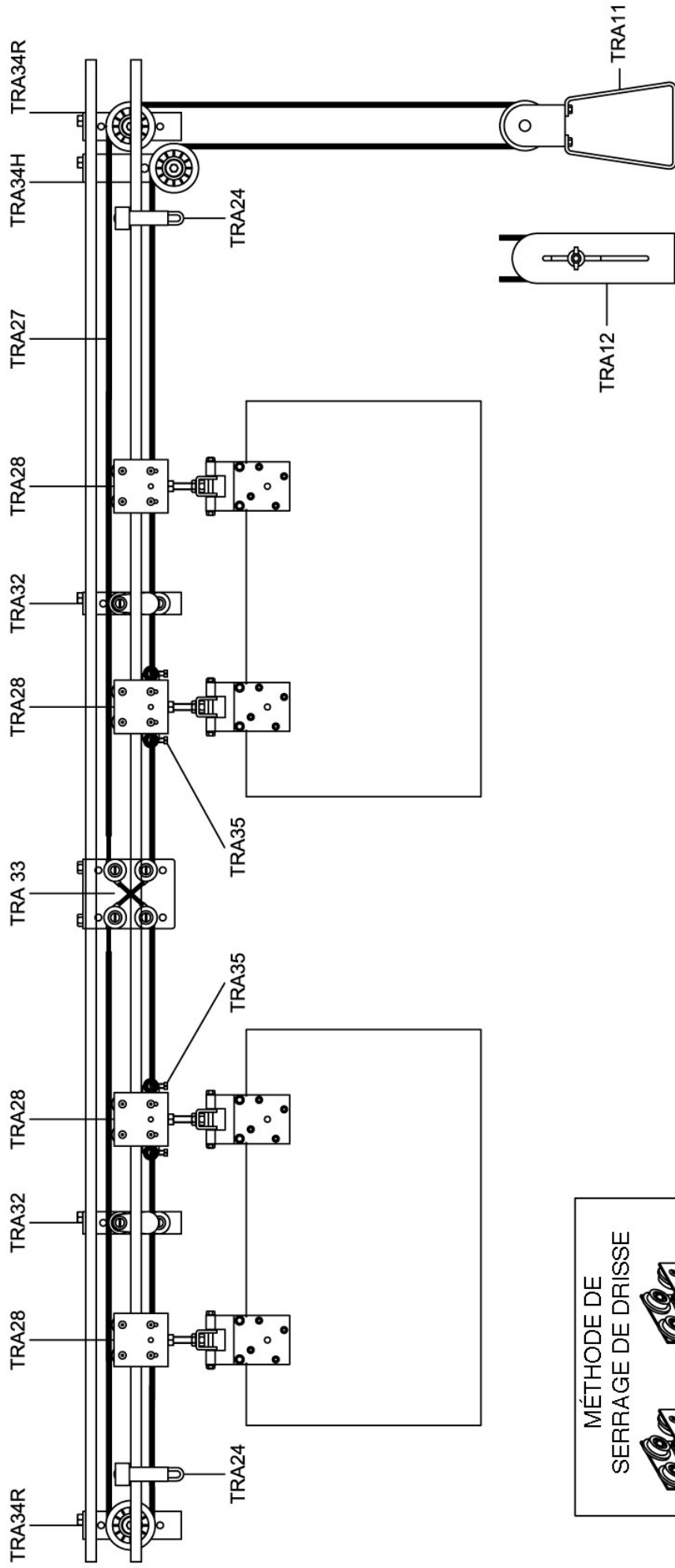

PLAN DE DRISSAGE / TIRAGE 16
 DRISSAGE LATÉRAL POUR PATIENCE
 POUR DÉCORS SIMPLES A BUTÉE CENTRALE
 (VUE DE CÔTÉ)



Tél : 01 40 11 50 50
 info@blackout.fr
 www.blackout.fr

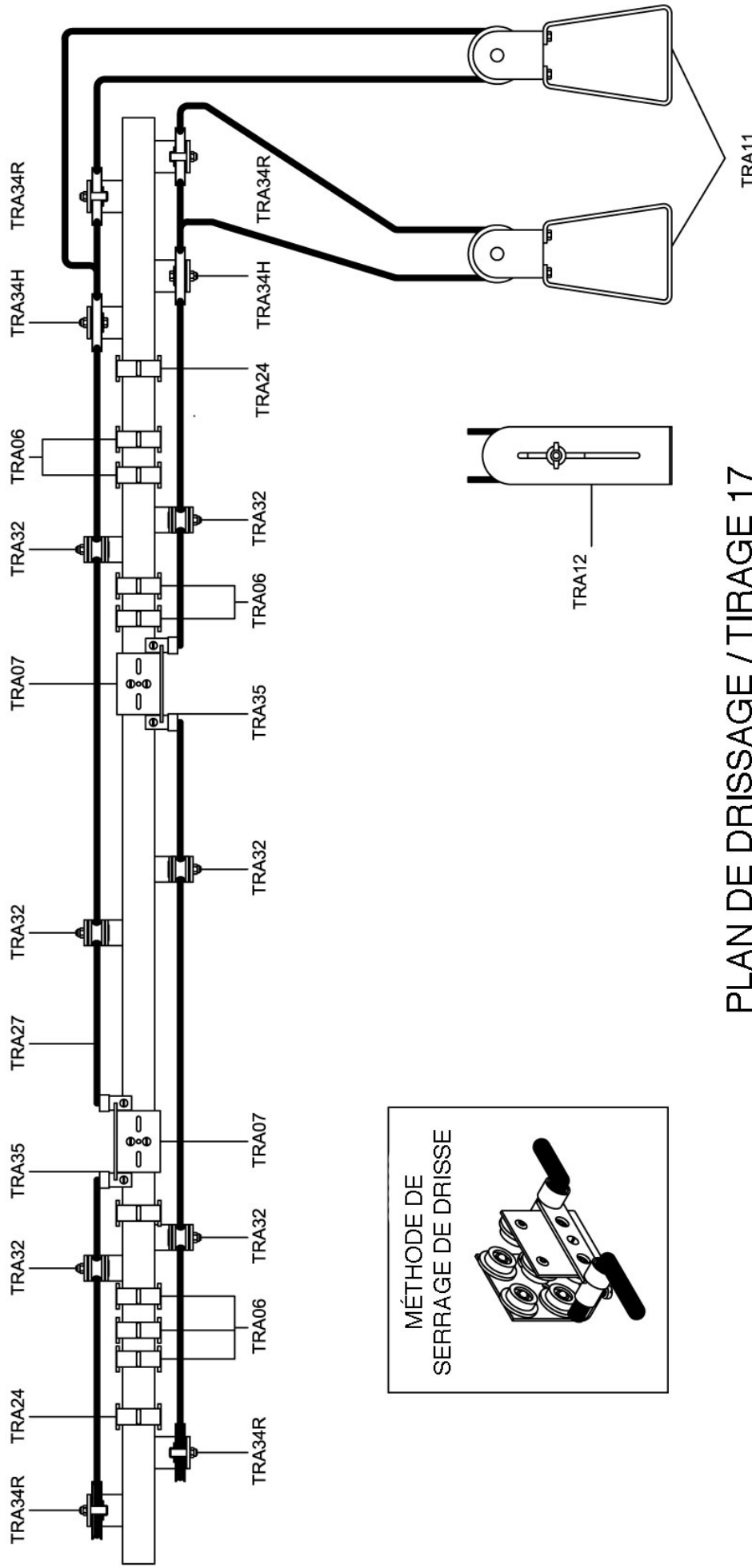

PLAN DE DRISSAGE / TIRAGE 17
 DRISSAGE LATÉRAL DE PATIENCE SIMPLE
 AVEC CHARIOTS MAÎTRE INDÉPENDANTS
 POUR 2 RIDEAUX
 (VUE DE DESSOUS)



Tél : 01 40 11 50 50
 info@blackout.fr
 www.blackout.fr

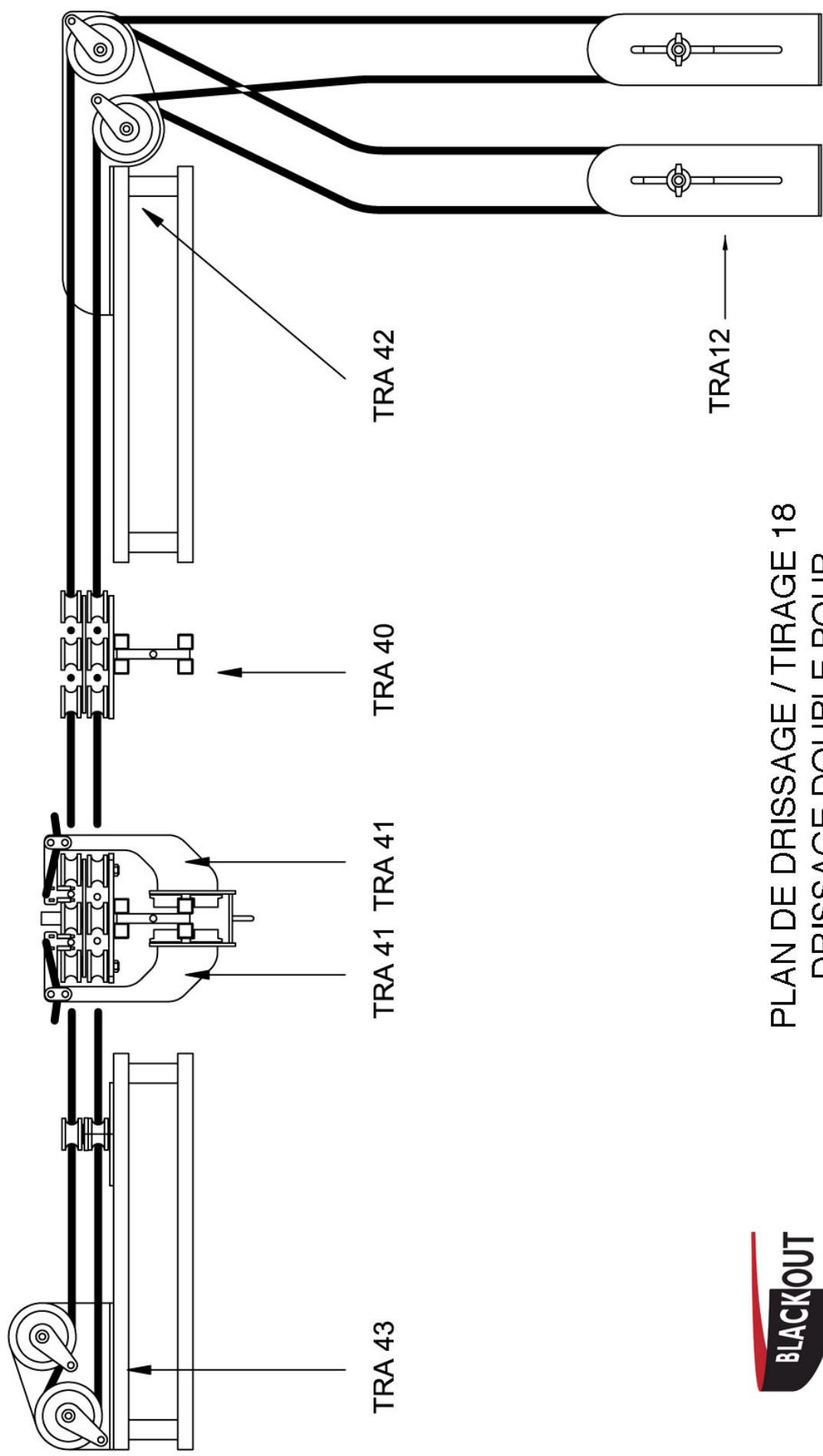

PLAN DE DRISSAGE / TIRAGE 18
 DRISSAGE DOUBLE POUR
 PATIENCE CINTRÉE
 (VUE DE CÔTÉ ET COUPE)



Tél : 01 40 11 50 50
 info@blackout.fr
 www.blackout.fr